

Pacific Teak

MILLWORKS



INSTALLATION & OPERATION INSTRUCTIONS

Installation Instructions

At Pacific Teak Millworks we are committed to providing you the most beautiful, finest quality outdoor living cabinetry available. Properly installed and cared for, your premium teak outdoor cabinetry will provide a lifetime of beauty, enjoyment and perfect operation in your outdoor room. Please read this entire instruction sheet prior to installation, and pay close attention to the information below.

Important. Before you Begin:

- **⚠️WARNING:** Drilling, sawing, sanding or machining wood products can expose you to wood dust, a substance known to the State of California to cause cancer. Avoid inhaling wood dust or use a dust mask or other safeguards for personal protection. For more information go to www.P65Warnings.ca.gov/wood.
- If your cabinets are to be installed in an island with a barbeque grill, consult your grill instructions regarding "Clearances to Combustibles". An insulated grill liner may be required.
- Be careful not to drop Door or Drawer Chassis'. It will damage the Outer Flange.
- Be careful not to damage the 2 black plastic expansion pin bushings on either side of the Hinge Cylinder.
- It is easier to install Doors *after* Door Chassis' are installed in the island. Conversely, it is easier to install Drawer Fronts *before* Drawer Chassis' are installed.
- When drilling holes, always use sharp bits. Drill slowly and carefully, and do not apply excessive pressure on the tip of the bit.
- When installing Door and Drawer Handles, always drill small pilot holes before drilling the final holes to avoid chipping. Drill final holes from the front side to avoid chipping the face of the Door or Drawer Front.
- There are 2 sets of handle screws included with our hardware kits. The longer screws are for mounting handles on the outer frames of all doors and drawer fronts. The smaller screws may be used if mounting handles in the center panels of Shaker or Cottage style doors and drawer fronts.
- If the handle screw heads create a gap between the drawer box and drawer front, you may countersink the screws into the drawer face frame about 1/8" or drill a partial or complete clearance hole in the drawer box where the screws touch.
- If installing handles in the same location on multiple doors or drawer fronts, you can finish drilling the first one, then use it as a template to drill the others. Line them up carefully and drill one at a time.
- Carefully drill pilot holes through mounting flanges at each screw location before installing screws. Installing screws without pilot holes may cause wood to split which is not covered under your warranty.
- All hardware, including Hinges, Drawer Glides, Handles and Installation Hardware, is included with Door and Drawer Chassis', not with the Doors or Drawer Fronts.
- All cutout dimensions below are in inches and provide 1/4" total tolerance vertically and horizontally. Be careful not exceed the dimensions shown.

Cutout Dimensions

Models	A (Width)	B (Height)	C (Depth)
CH-DO1-18; AD1-(18S/18C/18LR/ & 18LL)	17.25	21.25	3.25
CH-DO2-30; AD2-(30S/ 30C/ & 30L)	29.25	21.25	3.25
CH-DO2-34; AD2-(34S/ 34C/ & 34L)	33.25	21.25	3.25
CH-DR1H-18; UD1-(18S/ 18C/ & 18L)	17.25	7.25	20.25
CH-DR2V-18; UD2-(18S/ 18C/ & 18L)	17.25	21.25	20.75
CH-POTT-18; POTT-(18S/ 18C/ & 18L)	17.25	21.25	20.75
CH-POHDL-18; POHDL-(18S/ 18C/ & 18L)	17.25	21.25	23.75
CH-CO21-35; CO21-(35S/ 35C/ & 35L)	34.25	21.25	20.75

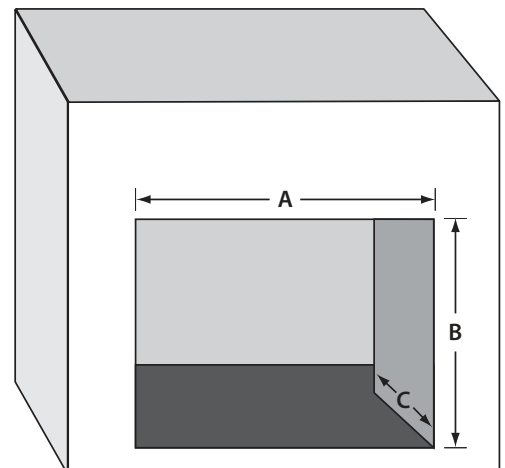

Installing Drawers:

- a. Install Handles on Drawer Fronts and carefully set them aside.
- b. Place the Drawer or Combo Chassis at a comfortable working height. Take care not to damage the beveled flange around the face of the chassis.
- c. Your Soft-Close Drawer Glides include an orange release/ adjustment mechanism (Figure 1.) at the front of the Glide with a blue release trigger to remove the Drawer, and a blue Drawer adjustment which allows you to level and adjust the height of the Drawer. Set the Drawer adjustment to the fully “**down**” position by pushing the blue tab **back** toward the rear of the drawer box.
- d. With the Drawer box in the fully “**closed**” position, insert the Drawer Front into the opening and against the drawer box. If your Chassis includes more than one Drawer, start with the bottom Drawer and work your way up.
- e. Center and align the Drawer Front. Place shims under and in the sides of the Drawer Front to keep it in position.
- f. Carefully secure the Drawer Front and install screws through the 2 middle, pre-drilled screw holes, and into the two round plastic inserts located in the back side of the Drawer Front.
- g. Repeat “e.” and “f.” above for each Drawer.
- h. With all Drawer Fronts mounted, check the alignment and center gaps on all sides. To make side to side adjustments, loosen the screws in the plastic cups, re-shim and reset screws. Use the blue adjustment tabs on each Drawer Glide to raise or level Drawers.
- i. When the Drawers are level and centered, pre-drill pilot holes, and secure the Drawer Fronts to the Drawer Boxes using screws provided.
- j. Remove the Drawers from the Chassis in the fully “**open**” position by depressing the blue triggers shown in Figure 2. and lifting Drawers out. Carefully set Drawers aside.
- k. Install the empty Drawer Chassis in the island using screws appropriate for your island material.
- l. To re-install Drawers, extend the Drawer Glides into the fully “**open**” position. Rest the Drawers on the Glides, then push them into the Chassis until you hear them “click” into position.

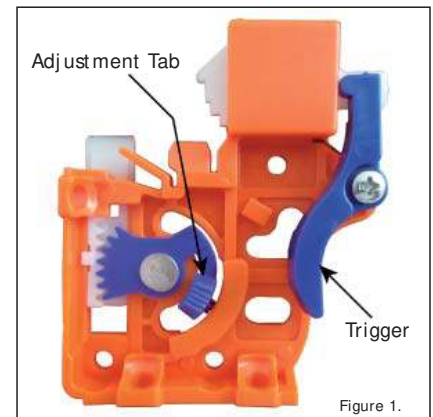

Installing Doors:

Note: When installing or removing hinges from a door, the hinge top clip must be completely in the “up” position, and the hinge arm should be fully extended in the “door open” position as shown in Figure 2.

- a. Install Handles on the Doors and carefully set them aside.
- b. Place the Door Chassis face down on a flat, smooth surface taking care not to damage the flange. Press **upward** on the release Trigger and detach The Hinge from the Mounting Plate.
- c. With Top Clips fully **open**, press the Hinge Cylinder and Expansion Pins into the matching holes in the Door until the Hinge Head is completely flush with the Door surface. Be careful not to damage the black plastic Pin Bushings.
- d. Push the Clip Tops **down** to secure the Door.

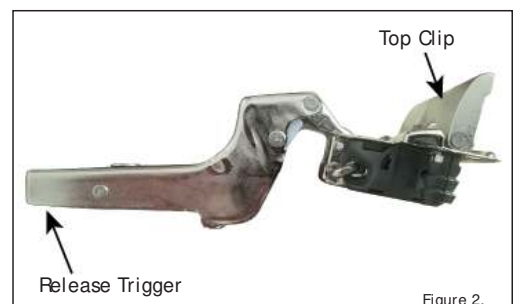

Note: To hide mounting screws, install them under the hinges, about 1/2” in front of the Hinge Plates.

- e. Pre-drill installation holes in the Flanges, and install the Door Chassis into the island opening using screws appropriate for your island material. Make sure the Chassis is level and square.
- f. Attach Hinges and Door as a unit to the Hinge Plates with the Door in the “**open**” position. Engage the metal Pin located under the front of each hinge arm into the hooks at the front of the hinge mounting plate, then press **down** on the back of the Hinge body to lock in place.
- g. Adjust Door alignment as shown on the next page.

Adjusting Doors:

Side adjustment

Rotate front screw to increase or decrease door overlay (± 2 mm).

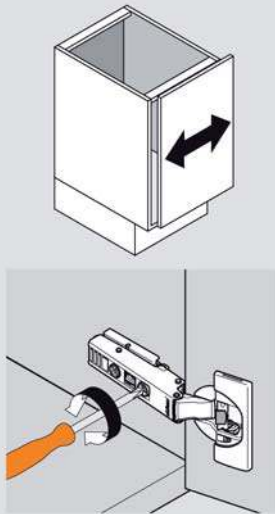

Height adjustment

Rotate cam screw on mounting plate to adjust door position (± 2 mm).

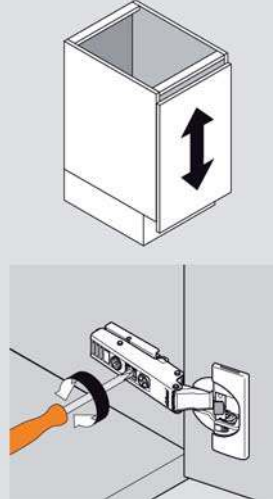

On non-cam mounting plates, loosen screws, adjust door and retighten screws.

Depth adjustment

Rotate rear spiral tech cam screw to adjust door gap ($+3$ mm, -2 mm).

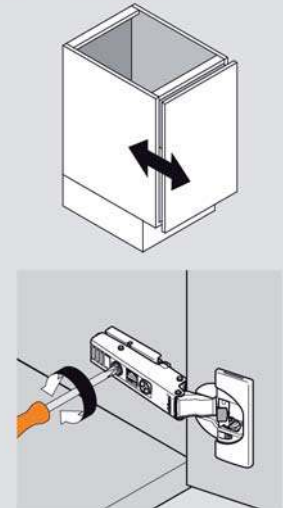

Switch on hinge cup

For small or light doors, the BLUMOTION can be deactivated on one of the hinges.

Door must be closed once for the deactivation to be complete. To reactivate, move switch back to original position.

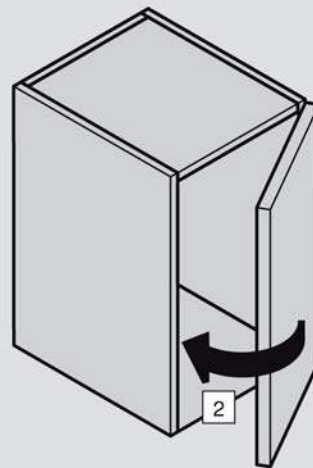
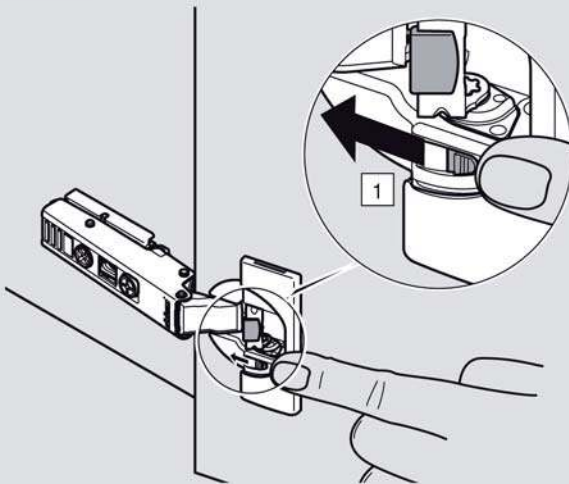

Pacific Teak
MILLWORKS

33951 Valencia Place
Dana Point, CA 92629
info@pacifictcakmillworks.com
www.pacifictcakmillworks.com